



ANT Channel Search

ABSTRACT

ANT channel search allows a device configured as a slave to find, and synchronize with, a specific master. This application note provides an overview of ANT channel establishment, and search modes. A search's impact on the performance of existing channels, and latency and power consumption are discussed, as well as special searches: background channel type, as well as high duty search, and continuous scan.

COPYRIGHT INFORMATION AND USAGE NOTICE

This information disclosed herein is the exclusive property of Dynastream Innovations Inc. No part of this publication may be reproduced or transmitted in any form or by any means including electronic storage, reproduction, execution or transmission without the prior written consent of Dynastream Innovations Inc. The recipient of this document by its retention and use agrees to respect the copyright of the information contained herein.

The information contained in this document is subject to change without notice and should not be construed as a commitment by Dynastream Innovations Inc. unless such commitment is expressly given in a covering document.

The Dynastream Innovations Inc. ANT Products described by the information in this document are not designed, intended, or authorized for use as components in systems intended for surgical implant into the body, or other applications intended to support or sustain life, or for any other application in which the failure of the Dynastream product could create a situation where personal injury or death may occur. If you use the Products for such unintended and unauthorized applications, you do so at your own risk and you shall indemnify and hold Dynastream and its officers, employees, subsidiaries, affiliates, and distributors harmless against all claims, costs, damages, and expenses, and reasonable attorney fees arising out of, directly or indirectly, any claim of personal injury or death associated with such unintended or unauthorized use, even if such claim alleges that Dynastream was negligent regarding the design or manufacture of the Product.

©2016 Dynastream Innovations Inc. All Rights Reserved.

TABLE OF CONTENTS

1	INTRODUCTION	3
2	RELEVANT DOCUMENTS	3
3	ANT CHANNEL SEARCH	3
3.1	CHANNEL SEARCH EXAMPLE	3
3.2	RELATIONSHIP BETWEEN MASTER AND SLAVE CHANNEL PERIODS	4
4	SEARCH MODES	4
4.1	SEARCH OPERATION	4
4.2	CONFIGURING SEARCH TIMEOUTS	5
4.3	CONSIDERATIONS	6
5	BACKGROUND SCANNING CHANNEL	6
5.1	BACKGROUND SCANNING CHANNEL EXAMPLE	6
5.2	CONFIGURING A BACKGROUND SCANNING CHANNEL	7
6	CONTINUOUS SCANNING CHANNEL	7
7	HIGH DUTY SEARCH	7
7.1	MULTI-CHANNEL CONSIDERATIONS	8
7.2	HIGH DUTY SEARCH EXAMPLE	8
7.3	CONFIGURING A HIGH DUTY SEARCH	8
8	SEARCH UPLINK	8
9	SEARCH WAVEFORMS	9
10	POWER AND LATENCY	9
11	CLOSING REMARKS	10

LIST OF FIGURES

Figure 3-1. Example Search	3
Figure 3-2. Relationship between Master and Slave Channel Periods.	4
Figure 4-1. Low and High priority search modes	4
Figure 4-2: Low and High Priority Search	5
Figure 4-3. Configuring Search Timeouts	5
Figure 5-1. Background Scanning Channel	6
Figure 5-2. Configuring Background Scanning Channel	7
Figure 5-1. Suppression Cycling	8
Figure 5-2. High Duty Search	8
Figure 9-1. Configuring Search Waveform	9

LIST OF TABLES

Table 1. Default and Special Timeouts	6
Table 2: Worst Case Channel Acquisition	10

1 Introduction

The ANT channel search feature allows slave devices to search, find and synchronize to appropriate transmitting master devices according to a set search criteria.

This application note describes the ANT channel search and acquisition process, search modes, as well as power and latency considerations. The search uplink and search waveform features are also described, as well as special search types: background scanning, high duty, and continuous scanning search.

2 Relevant Documents

It is strongly recommended that the following documents be reviewed prior to using this application note. To ensure you are using the current versions, check the ANT+ website at www.thisisant.com or contact your ANT+ representative:

- ANT Message Protocol and Usage

The following supplementary document may also prove helpful:

- AN Continuous Scanning Mode
- AN Multi-Channel Design Considerations
- AN Device Pairing

3 ANT Channel Search

ANT channel search allows an ANT slave device to search for, and acquire, an intended unique master.

Each ANT channel has an associated channel ID which is defined by the master device, and consists of the following parameters: Device Number, Device Type, and Transmission Type. Refer to the ANT Message Protocol and Usage document for more details. Once a master device's channel is opened, it will immediately begin transmitting its channel ID along with the data.

The slave device's channel ID represents the master device it wishes to establish communication with. It can be configured to search for a specific master, or to search for a subset of masters by using wildcards (0) in any of the channel ID parameters. When the slave's channel is opened, it will begin searching for the master according to the channel ID criteria.

The slave will search for a matching master signal until:

- Search is successful and master acquired
- Search duration reaches the user-defined time out period

The slave device will synchronize with the first matching transmission it finds. Once the slave has found a matching master, it will receive at the configured channel period (i.e. message rate). For the channel to maintain synchronization, the master and slave channel periods must either match, or be multiples of each other. If the slave's channel period is not exactly equal to the master's channel period, then missed messages will occur. The slave will send an EVENT_RX_FAIL (0x02) to its host MCU to indicate that a message was not received when expected.

After multiple, consecutive missed messages the slave device will drop back into search mode. If the message rate is slower than 2 Hz, the slave will go to search mode after four missed messages; for message rates faster than 2Hz, the slave will drop back into search after two seconds worth of missed messages.

The slave sends an EVENT_RX_SEARCH_TIMEOUT (0x01) to the host MCU to indicate a search has timed out on a receive channel. The channel is automatically closed.

3.1 Channel Search Example

Figure 3-1 shows a master device transmitting at a channel period of T_{ch} . When the slave opens its channel, it will immediately enter search mode. Note, the radio is only intermittently active rather than consistently active, helping to conserve power. This also means that the slave may not detect the first master transmissions that occur immediately after the slave has opened its channel and started searching.

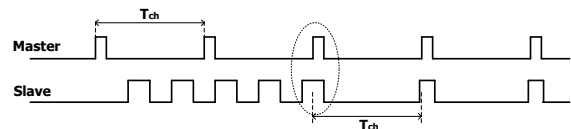

Figure 3-1. Example Search

Once the master transmission has been received (shown as circled in Figure 3-1), the slave will exit search mode and enter tracking mode. In tracking mode, the slave will receive at its designated channel period, which in this case is also T_{ch} . The slave will receive a message from the master on each designated timeslot, which ANT passes to the host and also uses for channel synchronization. For a bidirectional channel, the slave can optionally

transmit data back to the master device in the reverse direction on each channel timeslot.

3.2 Relationship between Master and Slave Channel Periods

Once a channel has been acquired, the channel period can affect the latency and power performances of the devices. Best practice is to set the slave's channel period equal to, or a multiple of, the master's channel period. Figure 3-2 shows examples where the slave's channel period is: (a) multiple; (b) factor; and (c) unrelated to the master's channel period.

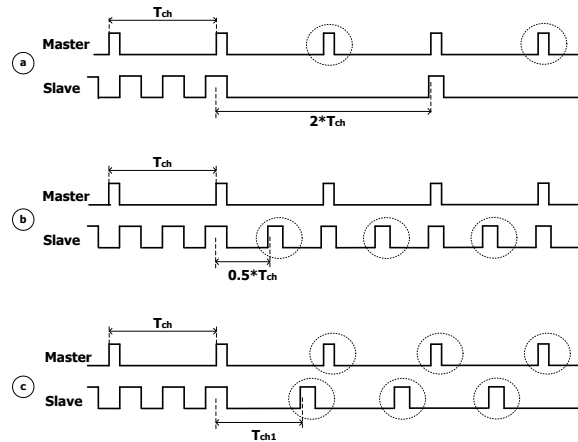

Figure 3-2. Relationship between Master and Slave Channel Periods.

Part (a) illustrates the case where the slave's channel period is a multiple of the master's. The slave can maintain synchronization with the master as it will receive a message for each timeslot. Slowing the slave's message rate like this can be used to conserve power on the slave device; however, it is important to note that this will also result in missed transmitted data messages (circled) and should only be used if the intended application is tolerant to missed data packets and increased latency.

When the slave's channel period is a factor of the master's, as shown in (b), then `EVENT_RX_FAILS` will occur as no data was transmitted by the master when the slave was expecting to receive data (circled). The slave could possibly maintain synchronization in this case, and should receive the transmitted messages; however, this situation wastes power on the slave device and should be avoided.

* For nRF24AP1 devices, when a slave channel is opened it will go immediately into a high priority

Another case that should be avoided is that described in part (c), where the slave and master channel periods do not match and are not multiples of each other. The slave will try to synchronize at its designated message rate T_{ch1} , resulting in multiple `EVENT_RX_FAILS` and missed messages (circled). There is a high potential that the number of missed messages results in the slave dropping back into search, and continually finding then dropping the master resulting in excessive power consumption and little or no data throughput.

4 Search Modes

Most ANT devices support two search modes, low priority and high priority, which differ in how existing channels are affected during channel acquisition. Low priority search provides the capability of searching for a master without interrupting other open channels on the device. A high priority search, as the name suggests, will take priority over any other open channels on that device, interrupting their operation. The nRF24AP1 supports high priority mode only.

Figure 4-1 illustrates the difference between the two search modes, showing a device with two open ANT channels: channel 0 is open and synchronized to another device (not shown) and channel 1 is in search mode.

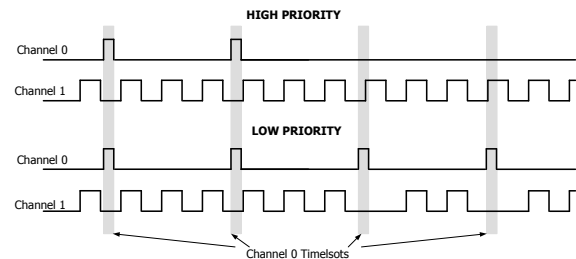

Figure 4-1. Low and High priority search modes

If channel 1 is in high priority (HP) search mode then any time there is an overlap of channel 0's timeslot and channel 1's active search time, then the search is prioritized and channel 0's Tx (or Rx) operation will not occur. On the other hand, if channel 1 is in low priority (LP) search mode, then the radio will Tx (or Rx) data on channel 0 rather than perform channel 1's search during the overlapping timeslot.

4.1 Search Operation

When an ANT channel is opened on a slave device, the search is automatically and immediately initiated. ANT will first search in low priority mode (if available¹), and then will only switch to high

search as there is no low priority search mode.

priority mode after a defined time out. If the high priority search also times out, then ANT will issue an EVENT_RX_SEARCH_TIMEOUT and close the channel ().

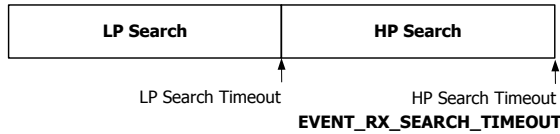

Figure 4-2: Low and High Priority Search

Search time outs for both low priority and high priority modes are independent, and can be adjusted to balance the latency of acquiring a new device with the performance effects on existing channels. These trade-offs are described below:

LP Search:

- Does not interfere with the operation of existing channels while searching for a master
- Typically results in similar latency and power consumption as HP search
- Does not ensure low latency acquisitions, and in some very rare cases may not result in an acquisition at all

HP Search:

- Existing channels will be interrupted if their timeslots overlap with the search
- Up to 50% of data messages on existing channels can be lost during search
- Will ensure a master is found with low latency (i.e. short acquisition times)

When configuring the low and high priority mode time outs, it is important to take these trade-offs into consideration. For example, the low priority search time out should be long enough to allow for most acquisitions to occur through a low priority mode search (i.e. without affecting existing channels); and that high priority should be short enough to not interfere significantly with other open channels.

Either mode can be disabled as desired. However, care should be taken to avoid disabling both time outs at once, as this would result in an EVENT_RX_SEARCH_TIMEOUT (and channel closure) immediately after the channel was opened. See AN Multi-Channel Design Considerations for

further discussion on this topic.

4.2 Configuring Search Timeouts

The search mode time outs can be configured using the following commands:

LP Search:

- Set Low Priority Search Timeout (0x63)

HP Search:

- Set Channel Search Timeout (0x44)

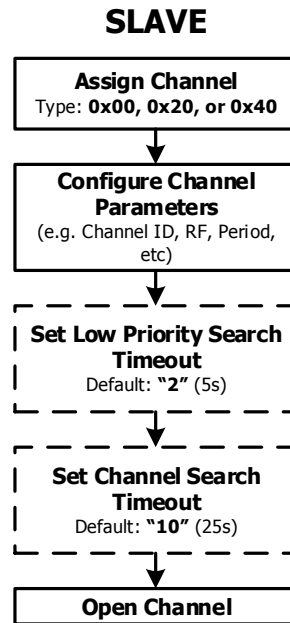

Figure 4-3. Configuring Search Timeouts

These commands can be used to set the maximum duration (in intervals of 2.5 seconds) that ANT will search for a device in each respective mode.

For example, the default low priority search time out value is 2, which results in 5 seconds of low priority mode search before switching to high priority mode, as shown in Figure 4-1.

The default high priority search time out value is 10, resulting in 25 seconds of high priority search before timing out, at which point ANT will send an EVENT_RX_SEARCH_TIMEOUT to the host and close the channel.

Note, for nRF24AP1 the only search mode available is an HP search, and its default timeout value is 12 (i.e. 30 seconds).

If search time out values other than the defaults are desired, these should be set prior to opening the channel, as shown in Figure 4-3.

4.3 Considerations

Low and high priority search time outs can be configured independently or combined depending on the requirements of the application. Using a combination of low and high priority search modes will guarantee that a new device will be found relatively quickly, while also limiting the performance effects on existing channels. Selection of time outs for both search modes is dependent on the master's message rate, data loss tolerance of existing channels, and the acceptable latency for acquisition of new channels. The default and max/min time out values are listed in Table 1. Default and Special Timeouts.

Table 1. Default and Special Timeouts

Value	HP Search Timeout (seconds)	LP Search Timeout (seconds)	nRF24AP1 Search Timeout (seconds)
Default	25 (0x0A)	5 (0x02)	30 (0x0C)
0x00	< 2.5	< 2.5	< 2.5
0xFF	Infinite	Infinite	10.5mins

The default values for both high and low priority search are optimized for a ~4Hz message rate. Care must be taken to ensure at least one of the time out values is non-zero.

An infinite search time out can be achieved by setting the time out value to 255, allowing a slave to search for a master indefinitely; except for nRF24AP1, which has high priority search only, and a value of 255 results in a maximum search time out of 10.5 minutes.

5 Background Scanning Channel

Background scanning channel is a special channel type that operates a search; however, instead of acquiring a master, ANT will pass the data to the host and continue searching.

The *Enable Extended Messages* (0x66) command can be used to allow the master's channel ID to be passed from the slave's ANT layer to host, along with the data message that was received. Should the slave device want to establish communication with that master, the host application can then use the received channel ID to open and establish another channel with that specific device.

As the name suggests, the background scanning channel will continue to search in the background,

passing on any received messages from master devices that are in the RF range. The slave's host application can then choose to ignore the transmission; or to open and establish a channel with those masters. Note that the background scanning channel will not receive messages from any master that has an established channel with the device. This is further explained in the example below.

5.1 Background Scanning Channel Example

Figure 5-1 provides an example background scanning slave channel operating on a device's channel 0. Two devices transmitting as master (MASTER_1 and MASTER_2) are also present and transmitting at their own channel periods, T_{ch1} and T_{ch2} , respectively. As described earlier, the search algorithm activates the radio intermittently in order to conserve power. As such, the slave may not catch all transmissions. The transmissions that are received by the background scanning channel are passed to the host application, along with the master's channel ID. In this case, on receiving MASTER_1's data and ID, the slave opens a second channel, ANT channel 1, with MASTER_1's channel ID. The background scan slave channel will continue to search and any new data received (such as transmissions from MASTER_2) will be passed to the host on channel 0. On channel 1, data from MASTER_2 is ignored; however, if communication with that master were desired, a third channel could also be opened, or the search uplink feature utilized (Section 8).

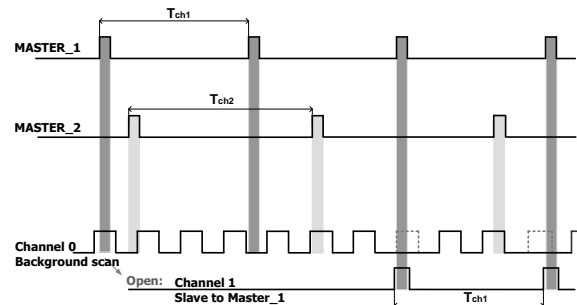

Figure 5-1. Background Scanning Channel

When data from MASTER_1 is received again, channel 1 will synchronize to that master channel. Note, the slave must have prior knowledge of the channel period T_{ch1} . Provided the search parameters are configured for low priority mode only (See Section 1), then channel 0 will only search when channel 1 is not active. In other words, priority of the overlapping timeslots will be given to channel 1. As such, channel 0 will never receive data from channel 1's master device.

5.2 Configuring a Background Scanning Channel

The necessary steps to configure a background scanning channel are shown in Figure 5-2. The background channel is enabled by setting the extended assignment byte to 0x01, and including this byte when sending the *Assign Channel* (0x42) command.

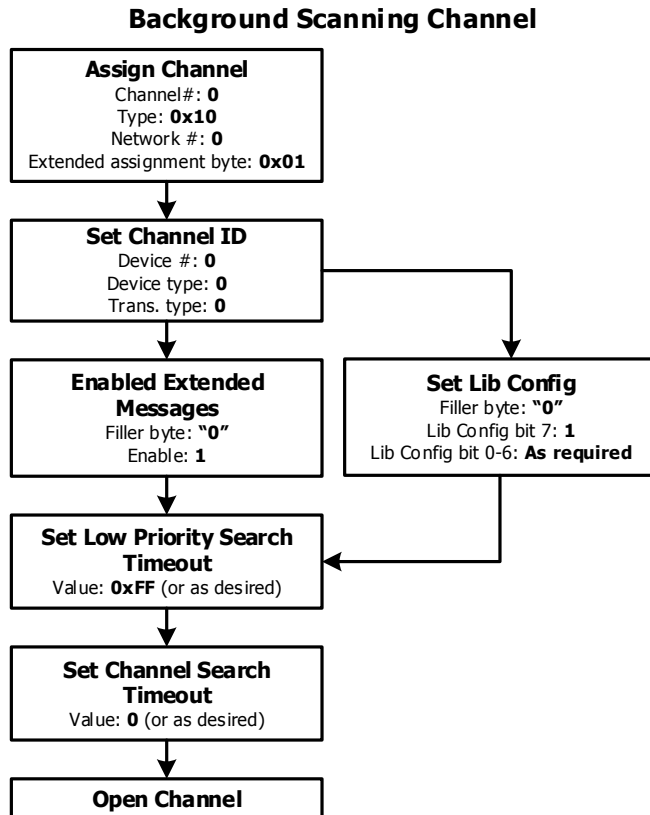

Figure 5-2. Configuring Background Scanning Channel

The Channel ID must also be set to define the background scanning channel's search criteria. In this example, all fields are wild carded and any ANT master device transmissions will be passed to the host application. The search criteria can be limited by setting one or more of the channel ID fields to a specific value. Refer to application note AN Device Pairing for more information.

Extended messages should also be enabled such that the slave host application can associate each received message with the appropriate master.

The low and high priority search time outs must also be set appropriately. It is recommended to set a short high priority search mode and set the low priority search mode to the desired duration. Setting a short high priority search time both allows other channels open on the device to continue

functioning relatively uninterrupted, but also limits how much other channels may impact the operation of the background scan. In this example in Figure 5-1, the high priority mode is disabled and the low priority mode is assigned an infinite time out. See AN Multi-Channel Design Considerations for further discussion on the impact of high priority search on a background scan use case.

The final step is to open the channel.

6 Continuous Scanning Channel

Continuous scanning mode configures the radio receiver to be always on. It uses all of the channel resources such that no other channel may be open when a continuous scan is open. Continuous scan mode is ideal for topologies where the master transmits asynchronously and intermittently, or to receive from a large number of masters simultaneously. See AN14 Continuous Scanning Mode for more information about this mode and how to configure it.

7 High Duty Search

High duty search is a mode the radio can be placed in to reduce channel acquisition latency.

In high duty search mode, if a channel is in search, the receiver enters an always on mode searching for a master until a channel is acquired. Similarly, in high duty search mode, if a channel is configured as a background scan, the radio receiver will be on almost all of the time performing a background scan.

High duty search is ideal for situations where a low latency is required for channel acquisition as it provides an average acquisition latency of $\frac{1}{2}$ a channel period.

The high power nature of a search in high duty mode should be taken into account before enabling high duty search in an application. High duty search should only be used on platforms that have considerable power resources available such as PC and mobile applications. Note that some devices that are oriented towards high power platforms have high duty search enabled by default.

Not all parts support high duty search. See the ANT Message Protocol Document for supported parts.

Because of the always on nature of high duty searches, a search in high duty mode may interfere with the performance of other ANT channels, and may also affect co-existence with other protocols on multimode communication chipsets. Section 7.1 discusses ANT channel interference considerations further.

7.1 Multi-Channel Considerations

Unlike continuous scanning mode, multiple channels are allowed to operate in high duty search. If a channel has a higher channel search priority than other channels, its search will preempt all other searches. See the AN 15 Multi-Channel Design Considerations application note for further information.

Low priority and high priority search time-outs may be specified as described in Section 1. After the low priority search times out, the high priority search will come into effect.

While other channels are able to operate in high duty search mode, the intensive nature of the search may cause interference (channel collisions) while the search is in high priority search mode. See Section 1 for an explanation on how search modes work. A high priority search can cause other channels to be blocked for extended periods of time. To avoid this, high duty search implements suppression cycles.

7.1.1 Suppression Cycle

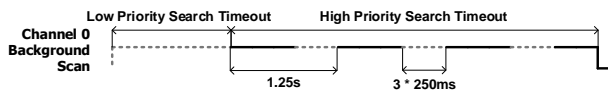

Figure 7-1. Suppression Cycling

Suppression Cycling works to avoid extensive periods of message loss on other operational channels while a channel is performing a search in High Duty Search Mode. When a High Duty Search enters high priority search mode, the suppression cycling mechanism throttles the high priority search into low priority search depending on the suppression parameter configured.

If a suppression cycle parameter of zero is specified, the high priority search is not throttled, and the high priority search remains in high priority until its time-out. If a suppression cycle of 5 is specified, when the low priority search times-out and the high priority search should kick in, the low priority search continues until the high priority search times-out.

For values in between 0 and 5, within a 1.25 second search period, high priority and low priority searches are alternated in 250ms sections when in high priority search mode. See Figure 7-1.

Regardless of the suppression cycle parameter, the search length remains the sum of the low priority and high priority search time-outs, with the high priority search mode following the low priority search mode.

7.2 High Duty Search Example

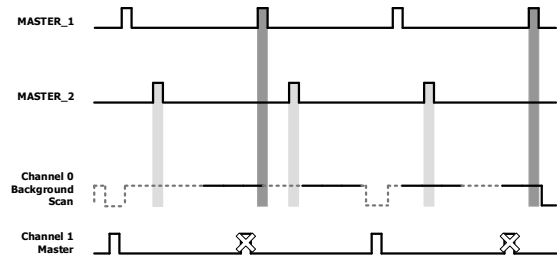

Figure 7-2. High Duty Search

Figure 7-2 describes the receive behavior of a background scan in high duty search mode with another channel running on chip. As shown in the figure, messages may not be received on the background scan when the channel is in low priority search mode. Alternatively, master channel 1 may be unable to transmit when the background scan is in high priority search mode.

7.3 Configuring a High Duty Search

To configure a high duty search:

1. Close all channels
2. Send High Duty Search Command with the desired suppression cycle parameters
3. Open Channel

All searches on all channels will now be performed in High Duty Search Mode.

8 Search Uplink

One limitation of the channel search feature is that, with the exception of continuous scan, messages cannot be sent on the back channel of messages received in search. This includes responses to acknowledgement and burst messages, and messages received on a background scan channel, effectively making the background scan channel an rx-only channel. To address this limitation, some parts support the search uplink feature.

The search uplink feature allows messages to be sent on the back channel of messages received during an active search. This allows for messages to be transmitted by a slave as soon as a channel is acquired, thereby reducing the latency of that first message transmission, and for bi-directional communication to occur on an active background scan channel. The uplink ability also allows for acknowledgement and burst messages to be sent from a transmitter, and to be received on an active background scan channel, or during channel acquisition.

Only “active” searches are able to send uplink messages. An active search is the search which is currently using the radio’s resources. Which search is currently active depends on channel priority, and the order of the opening of the channels. If two searches have the same channel parameters and search priority and are running simultaneously (and thus are both active), the channel that opened first is the channel that is able to send uplink operations. The active search restriction has implications particularly in cases where background scan is left open constantly to scan for devices and other channels are being opened to track specific devices.

The search uplink feature is only available on some parts. See the ANT Message Protocol Doc for which parts support search uplink. Support is also indicated by a capabilities bit.

Active searches on devices with the uplink feature will respond to acknowledgement and burst messages with acks. Uplink broadcast, and acknowledged messages can be sent by an active search, but bursts cannot be sent as uplinks. Search devices can have messages pending on the searching channel that will be sent when the master device is acquired. Messages can be configured to be targeted to specific devices by setting the channel ID parameter to match the received message’s channel ID, or wild carded. Setting the channel ID explicitly will restrict background searches to only messages from that device until the message has been sent.

Messages can be targeted to specific devices by setting channel ID or wild carded to match the first device observed. Setting channel ID explicitly will restrict background search to only matching those devices until the message has been sent.

On devices that do not support the uplink feature, messages can be sent back to a transmitter found on a background scan by opening up a separate bi-directional channel tracking the transmitter, or by running a continuous scan channel instead of a background scan channel since continuous scan channels support sending messages in the reverse direction.

On devices that support search uplink, to revert to non-uplink behavior, open the background scan as an rx-only slave channel. On a channel search, to revert to non-uplink behavior, do not add messages to the message buffer until the channel has begun tracking.

9 Search Waveforms

The search waveform command controls the amount of time the radio hardware is active during a slave channel search, and consequently affects the balance between channel acquisition time and

average power consumption.

The standard ANT search waveform is optimized for reduced battery consumption – in consideration of coin cell battery operated devices. This trade-off between battery consumption and acquisition latency may not make sense for higher powered devices such as cellphones where battery consumption is not a concern. As such, the ANT Serial Interface exposes a way to change the waveform to a more appropriate one.

The search waveform may be set to two values: 316 (standard search waveform), and 97 (fast search waveform). The standard search waveform is ideal for coin cell operated devices, but has increased acquisition latency whereas the fast search waveform is intended for high power devices, and has low acquisition latency. Note that the default search waveform on USB-ms is the fast search waveform, and that the Set Search Waveform command may be used to set the standard search waveform instead.

Please also note that changing the search waveform after high duty search has been configured may have a detrimental effect on search acquisition time and should be avoided.

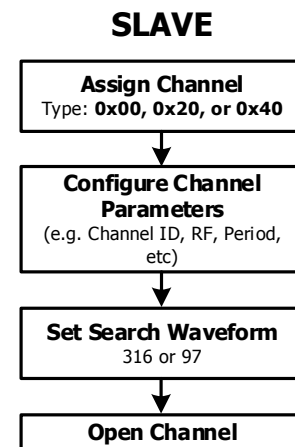

Figure 8-1. Configuring Search Waveform

Please also note that the fastest acquisition times can still only be achieved by devices in continuous scanning mode or with high duty search enabled.

10 Power and Latency

A slave device consumes more current during a channel search than it does when synchronized. The average current consumption in search mode is typically around 2 to 3 mA.

Acquisition times depend on the channel period of the master that is being acquired. The worst case

acquisition times for common transmission message rates are shown in Table 2.

Table 2: Worst Case Channel Acquisition

Message rate (Hz)	Worst Case Search Time (s)		
	Standard Search	Fast Search	High Duty Search
10	1.9	0.5	0.1
4	3.5	1.75	0.25
2	10	4.5	0.5
1	23	5	1

There is no mathematical formula for calculating these numbers. These estimates were empirically defined assuming zero packet loss and a favorable RF environment.

11 Closing Remarks

This application note provides an overview of the ANT channel search mechanism, including the low and high priority search modes and configuration combinations of these two modes to meet application requirements, and search uplink. Note, all diagrams are conceptual examples only and timing details are not to scale. Power consumption and latency considerations during channel acquisition are also provided. The background scanning channel type, high duty search, and continuous scan, all of whom rely on the search mechanism, is introduced and discussed.